







033579

NISSAN**FITTING INSTRUCTIONS**

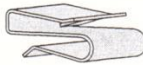
Part Name/Description: Protr - Hood, Clear / Protr - Hood, Smoked
 Applicability [Model code & Model Name]: T32 X-Trail (01/2014 onwards)
 Part No: (Clear) F5160-4CF0AAU / (Smoked) F5160-4CF0BAU

Fit Time: [20 Minutes]

Read instructions carefully before commencing this activity.**Kit Contents**

No.	Item Description	Quantity	Image	Service Part Number	Service Kit Quantity
1	Bonnet Protector	1		-	1
2	Metal Clip (For "Clear" Bonnet Protector only)	3		F5169-4CF0AAU	3
3	Black Metal Clip (For "Smoked" Bonnet Protector only)	3		F5169-4CF0AAU	3
4	Screw Plug	2		F5169-4CF0AAU	2
5	Self-Tapping Screw	2		F5169-4CF0AAU	2
6	Washer	2		F5169-4CF0AAU	2
7	Abrasive Resistant Tape	3		F5169-4CF0AAU	3
8	Alcohol wipe	1		F5169-4CF0AAU	1

B2395 - 1 - 22/01/2014

Page 1 of 5

In producing this document Nissan Motor Co. (Australia) Pty Ltd ("Nissan") has relied upon information and representations made by third party suppliers and to the extent permitted by law Nissan accepts no responsibility for any losses, faults or damage caused to the vehicle or accessory components that occur due to a failure to properly follow these instructions.

NISSAN GENUINE
PARTS | SERVICE | ACCESSORIES

Nissan Motor Co (Australia) Pty Ltd
 260-284 Frankston-Dandenong Road, Dandenong South Vic 3164

FITTING INSTRUCTIONS

Part Name/Description: Protr - Hood, Clear / Protr - Hood, Smoked
Applicability [Model code & Model Name]: T32 X-Trail (01/2014 onwards)
Part No: (Clear) F5160-4CF0AAU / (Smoked) F5160-4CF0BAU

Fit Time: [20 Minutes]

Read instructions carefully before commencing this activity.

Kit Contents

Tools Required

• No. 2 Phillips Head Screwdriver		

General Notes

- Read through the fitting instructions before installation of accessory.
- Always install the accessory following the fitting instructions. Failure to do so may cause damage to the vehicle or the accessory.
- Ensure all recyclable discarded vehicle/accessory components and packaging are recycled following local recycling regulations.
- It is always recommended that this accessory is fitted by a qualified Nissan Technician.
- Safely store and protect any removed vehicle components.
- Ensure all bare metal surfaces are protected using Automotive Bare Metal Primer and touch-up paint.
- Remove all metal swarf and dust from all vehicle surfaces if surface is used for accessory installation.
- Ensure all fasteners are torqued to the specifications as per FI if applicable.

Safety Notes

- Check that all work practises comply with safety standards.
- Appropriate clothing & PPE must be worn
- While using power tools or safety equipment, ensure safe procedures are followed.

FITTING INSTRUCTIONS

Part Name/Description: Protr - Hood, Clear / Protr - Hood, Smoked
Applicability [Model code & Model Name]: T32 X-Trail (01/2014 onwards)
Part No: (Clear) F5160-4CF0AAU / (Smoked) F5160-4CF0BAU

Fit Time: [20 Minutes]

Step 1

- Trial fit the Bonnet Protector (1) centrally onto bonnet.
- With a non-permanent marker, note the positions of the two middle slots in the bonnet protector (2) that correspond to the holes in the underside of the bonnet. Also note and mark the three push-on clip positions (3) corresponding to the holes of the Bonnet Protector.
- Remove Bonnet Protector.

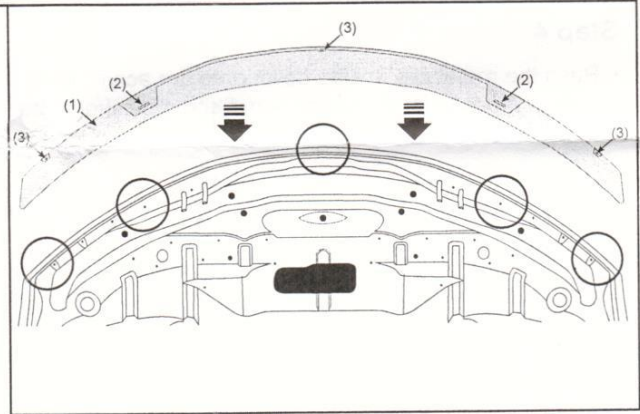

Step 2

- Insert the screw plugs provided into the two vacant holes.

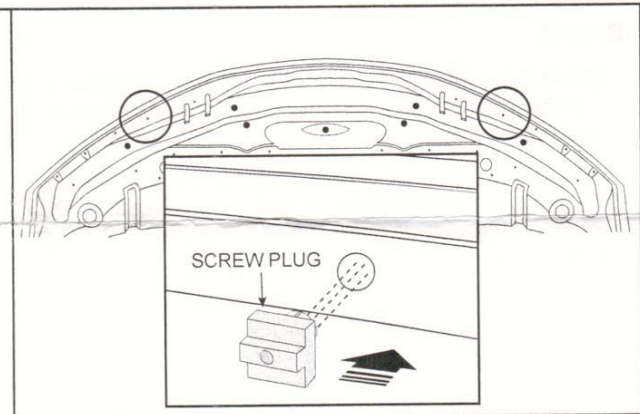

Step 3

- Push the metal wing clip onto the acrylic wing tags of the Bonnet Protector. A definite click should be heard when the acrylic tag engages with the metal clip.

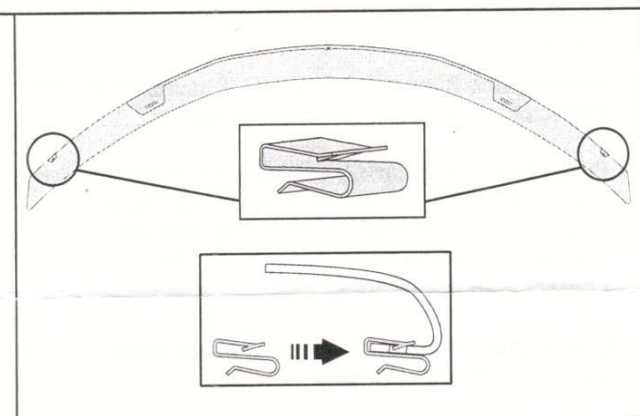

FITTING INSTRUCTIONS

Part Name/Description: Protr - Hood, Clear / Protr - Hood, Smoked

Applicability [Model code & Model Name]: T32 X-Trail (01/2014 onwards)

Part No: (Clear) F5160-4CF0AAU / (Smoked) F5160-4CF0BAU

Fit Time: [20 Minutes]

Step 4

- Push the metal clip upside down onto the acrylic wing tags of the Bonnet Protector. A definite click should be heard when the acrylic tag engages with the metal clip.

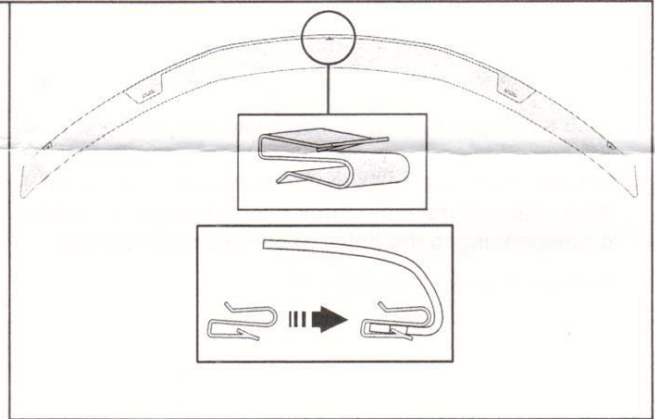

Step 5

- Clean the noted areas under the metal clip locations with the alcohol wipe provided. Wipe off any residue with a clean, dry cloth.
- Adhere the abrasive resistant tape strips over the bonnet lip. Apply the tape so that approximately half of each strip is on the top surface of the bonnet and half is on the underside.

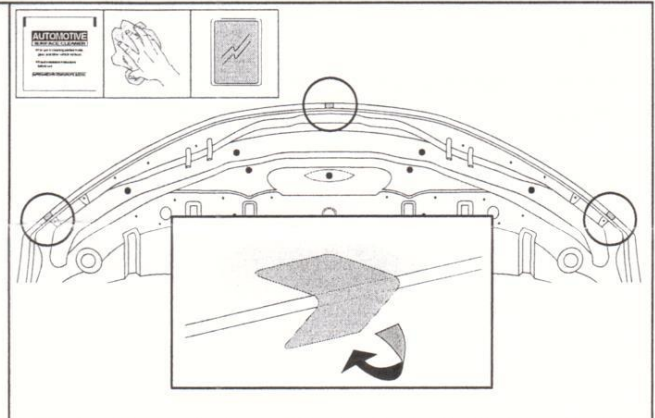

Step 6

- Re-install the Bonnet Protector (1). Ensure the Bonnet Protector is centrally located on the bonnet.
- Slide centre metal clip (2) onto the bonnet lip over the previously adhered abrasive resistant tape strip. **Ensure the metal clips are over the abrasion resistant tape and do not come into direct contact with the bonnet.**
- Ensure that the collar of the screw plugs locate into the slots in the Bonnet Protector tags (3).

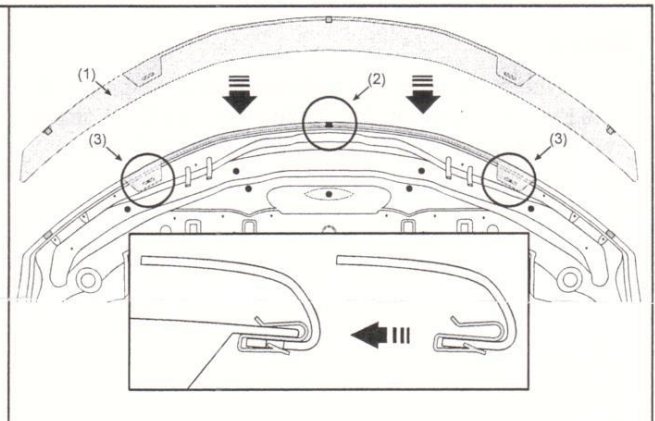

FITTING INSTRUCTIONS

Part Name/Description: Protr - Hood, Clear / Protr - Hood, Smoked
Applicability [Model code & Model Name]: T32 X-Trail (01/2014 onwards)
Part No: (Clear) F5160-4CF0AAU / (Smoked) F5160-4CF0BAU

Fit Time: [20 Minutes]

Step 7

- Insert the two screws through the washers into the screw plugs, but do not fully tighten.
- Ensure the Bonnet Protector is centrally located on the bonnet
- Fully tighten the two screws.

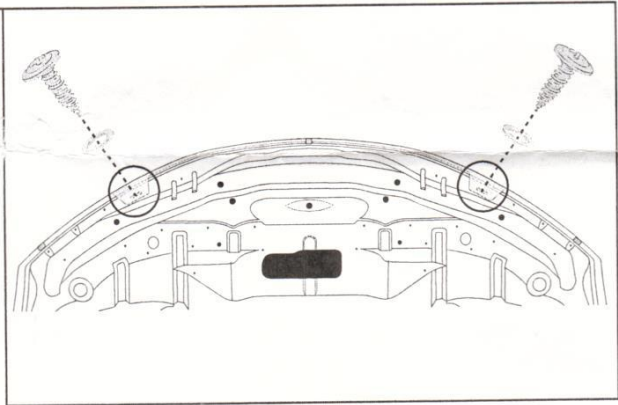

Step 8

- Slide the metal clips onto the bonnet lip over the previously adhered abrasive resistant tape strips. **Ensure the metal clips are over the abrasion resistant tape and do not come into direct contact with the bonnet.**

