

040 095

Fitting

INSTRUCTIONS



PRODUCT	Bonnet Protector	 20 MIN
APPLICATION	LDV T60 2022	
PART NO	LV520MAX	DATE - 03 June 2022

VERY IMPORTANT

- PLEASE READ THESE INSTRUCTIONS CAREFULLY BEFORE COMMENCING WITH FITMENT.
- ENSURE EACH STEP IS CHECKED AND TICKED OFF BEFORE MOVING ON TO THE NEXT STEP.

KIT CONTENTS

Item	Qty	Description	Item	Qty	Description
A	1	Bonnet Protector	F	2	Self-Tapping Screw
B	2	Fixed Metal Clip	G	2	Screw Plug
C	4	Push-on Clip	H	8	Abrasion Resistant Tape
D	6	Small Screw	I	1	Alcohol Wipe
E	6	Washer			

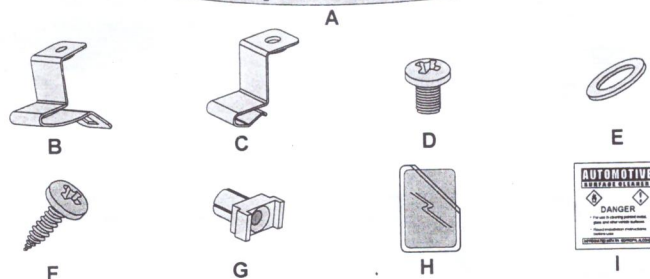
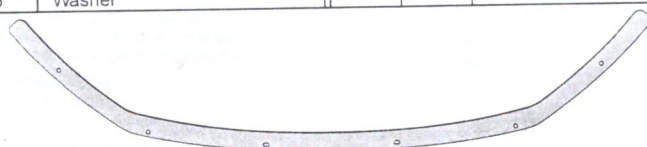

REQUIRED TO FIT	1x Bucket with soapy water mix	1x Pencil or non-permanent Marker
	1x Phillips Head Screw Driver	

PRECAUTIONS

Ensure that you adequately cover and protect Seats, Carpets, Body parts as well as Door entry areas with non-scratch covers, before installation. Ensure that your workmanship is of the highest professional standard and that you do not scratch or damage the vehicle or accessory to be fitted.

Before commencing with fitment, carefully unwrap the product and ensure that the kit is complete and that the part is free of damage.

INSTALLATION PROCEDURE

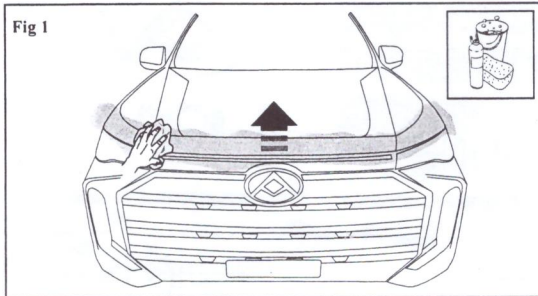

Read installation instructions thoroughly before commencing installation.

Open the bonnet and thoroughly clean and dry the top and underneath the bonnet and surrounding areas.

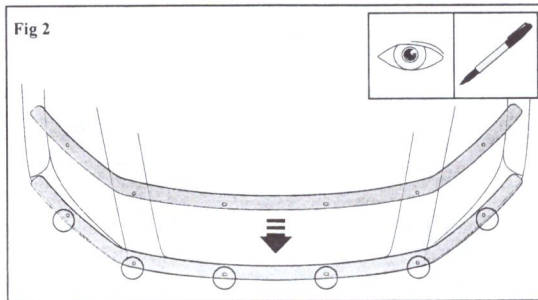

Trial fit the Bonnet Protector centrally on the bonnet.

Note the areas of the bonnet that correspond to the four holes and two slots in the Bonnet Protector and mark these locations on the bonnet.

Mark these positions on the bonnet with a non-permanent felt pen or pencil.

Remove the Bonnet Protector.

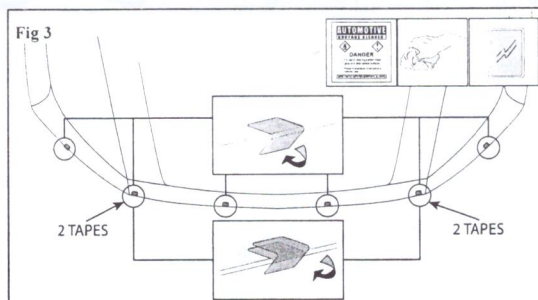

At each marked position, individually clean the topside and underside of the bonnet lip with an alcohol wipe, allow to dry and adhere the abrasion resistant tape over the bonnet lip at that exact location.

Apply the tape so that approximately half of each strip is over the topside of the bonnet and half is over the underside.

Repeat for all six locations.

Apply additional tape at the two locations highlighted.

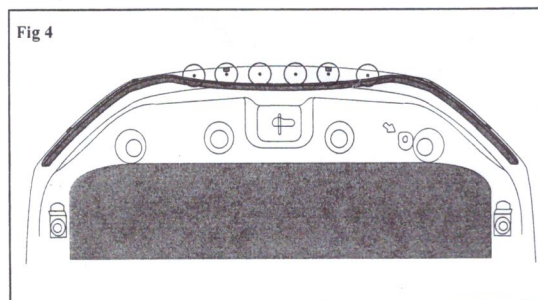

On the underside of the bonnet, pull the bonnet seals out at the six locations indicated.

INSTALLATION PROCEDURE

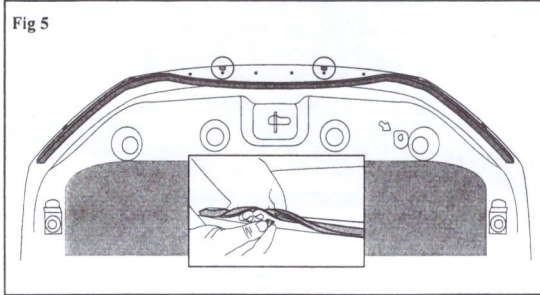

Remove only the plastic plugs in the seals corresponding to the two central abrasive resistant tapes and discard.

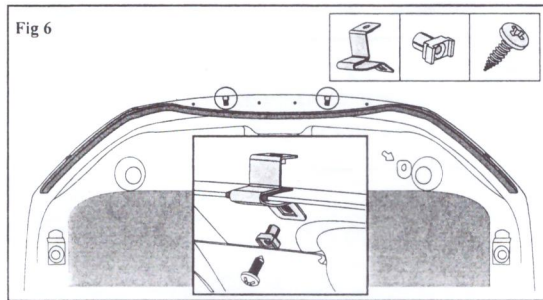

Slide the fixed metal clips onto the bonnet where shown, aligning them with the holes in the bonnet. Ensure the fixed metal clips are positioned over the abrasive resistant tapes.

Insert the screw plugs through the fixed metal clips and into the bonnet. Secure with the provided self-tapping screws.

Important  Ensure that the metal clips are located on the anti-abrasive tape and not on the bonnet surface.

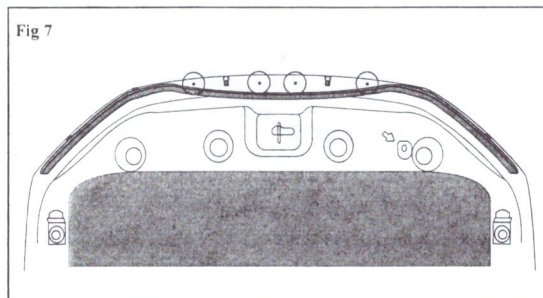

Re-install the bonnet seals by clipping the remaining plastic plugs into the bonnet where indicated.

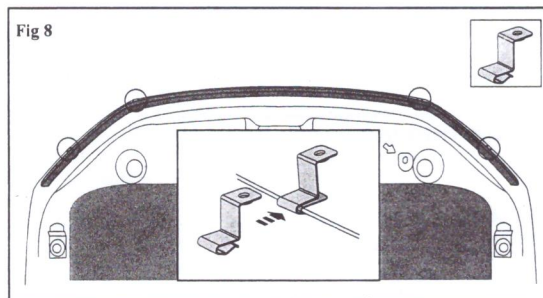

Slide the Push-on clips onto the bonnet where shown, aligning them over the abrasive resistant tapes.

Important  Ensure that the metal clips are located on the anti-abrasive tape and not on the bonnet surface.

INSTALLATION PROCEDURE

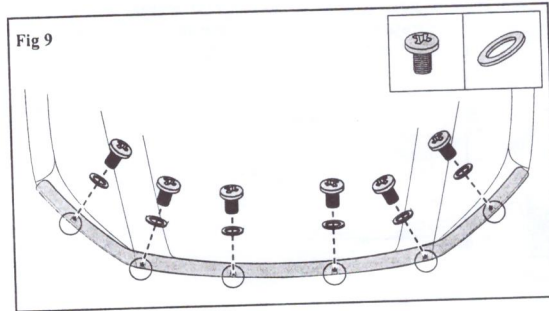

Re-fit the Bonnet Protector, ensuring it's central.
Fasten with the top screws and washers provided.

To Remove Bonnet Protector:
Reverse the above procedures.



Conduct final inspection, ensuring all screws are tightened, and clips are correctly installed and not touching the bonnet surface.

Care Instructions:



Clean with a mild detergent and water solution.



Do not use automatic car wash.



Do not use abrasive cleaners.