

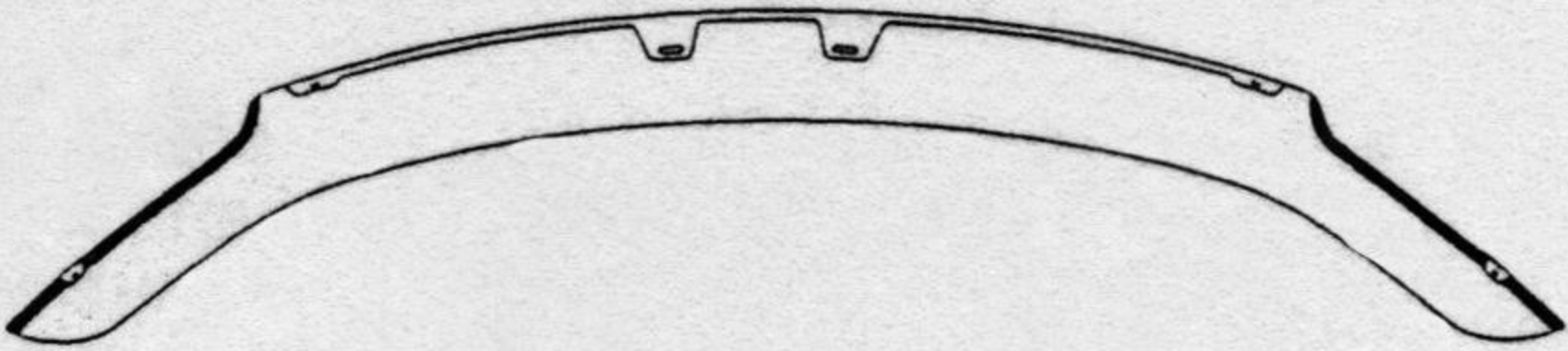





BONNET GUARD

INSTALLATION INSTRUCTIONS

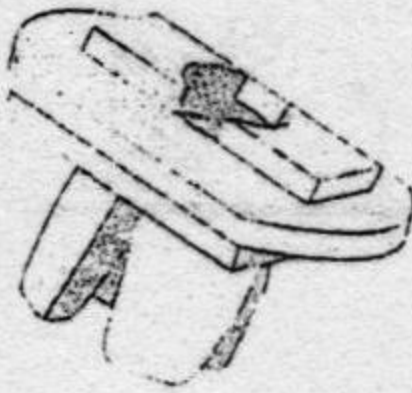
FOR:CR-V 2013

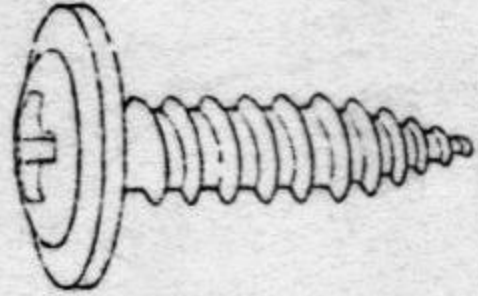
	QTY		QTY
<p>08P01-T1G-L00 PARTS LIST Bonnet Protector</p> 	1	<p>Abrasive Resistant Tape</p> 	4
<p>Screw Plug</p> 	2	<p>Alcohol Wipe</p> 	1
<p>Self Tapping Screw</p> 	2		
<p>Push-on Clip</p> 	4		
<p>Washer</p> 	2		
		<p>TOOLS REQUIRED</p> <ul style="list-style-type: none"> • Clean Cloth • Soapy Water • Sponge • Non-Permanent Marker, or Pencil • Phillips Head Screwdriver 	

BONNET GUARD

INSTALLATION INSTRUCTIONS

FOR:CR-V 2013

Note: Check contents before installation

Note: Read the following installation procedure before proceeding.



Do not use abrasive cleaners.



Clean Bonnet Protector with a mild detergent and water solution.

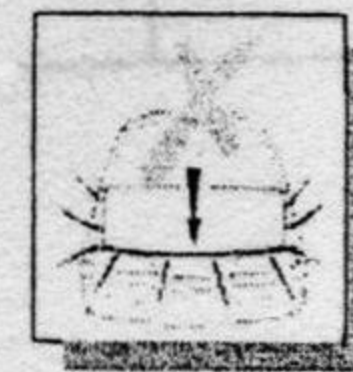

Do not slam bonnet.

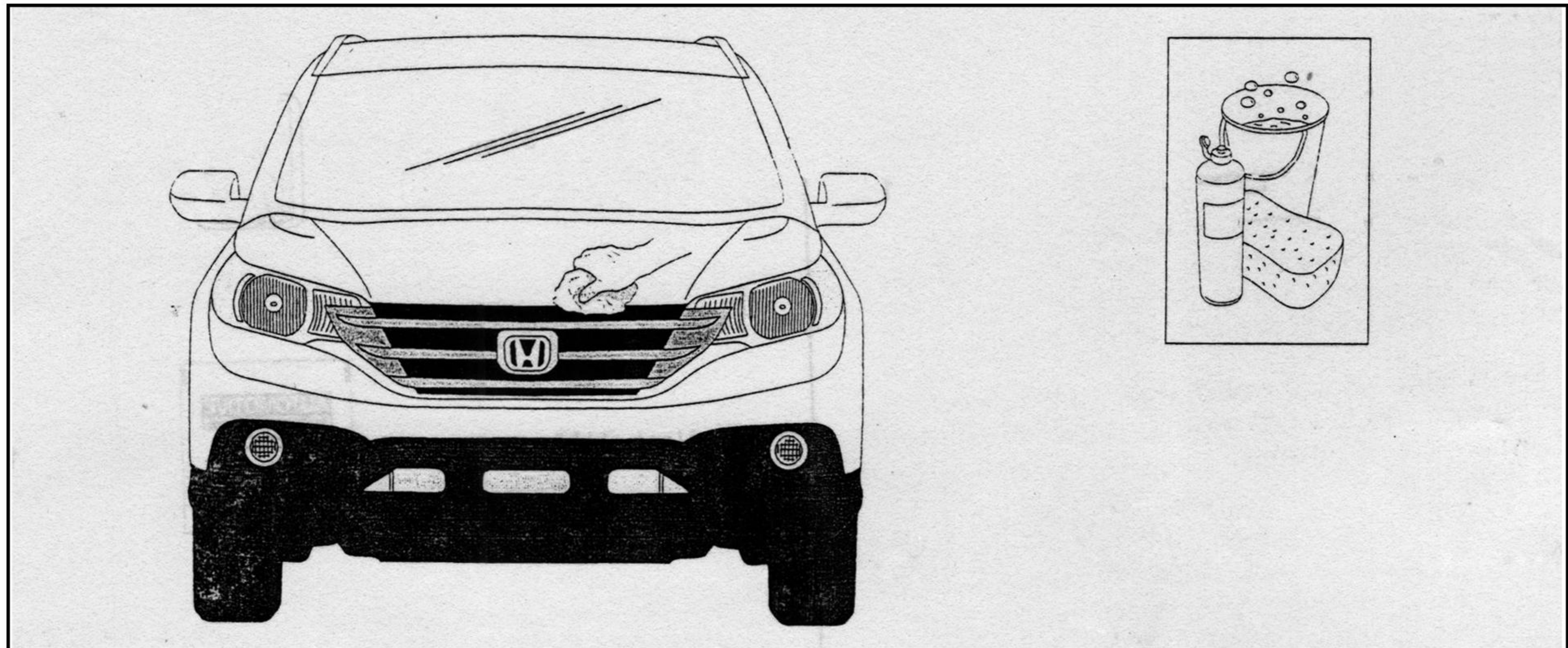

1. Wash the bonnet with a mild soap and water solution and dry thoroughly.

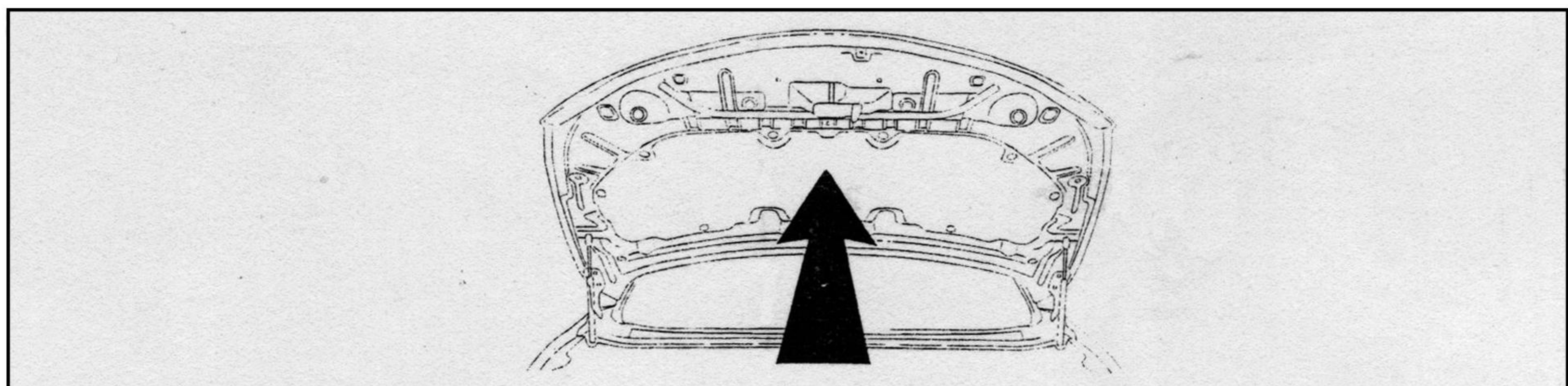

2. Open Bonnet.

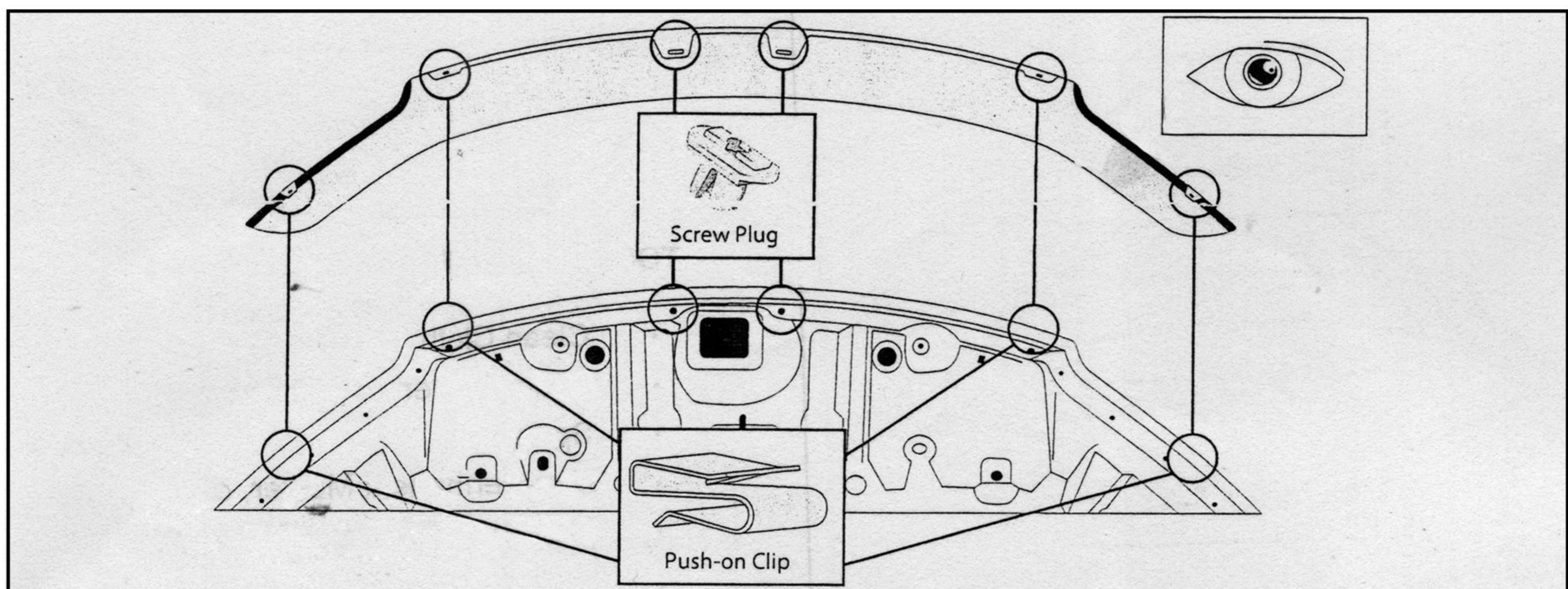

3. Loosely place the Bonnet Protector on the bonnet. Using a non permanent marker mark the location of the two acrylic tag slots for the screw plugs and the four acrylic tag slots for the push-on clips.

BONNET GUARD

INSTALLATION INSTRUCTIONS

FOR:CR-V 2013

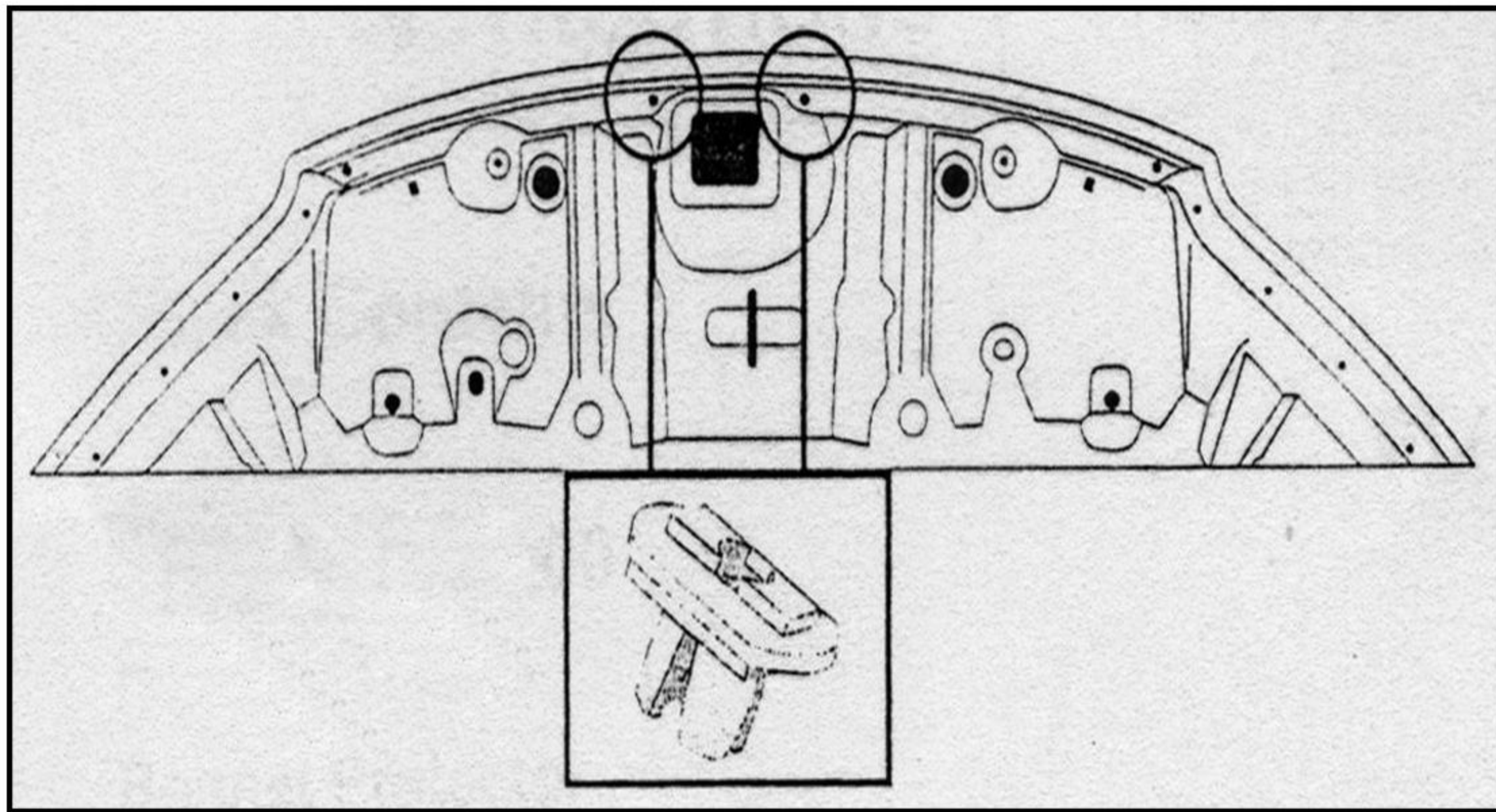

4. Press fit the screw plugs into the holes.

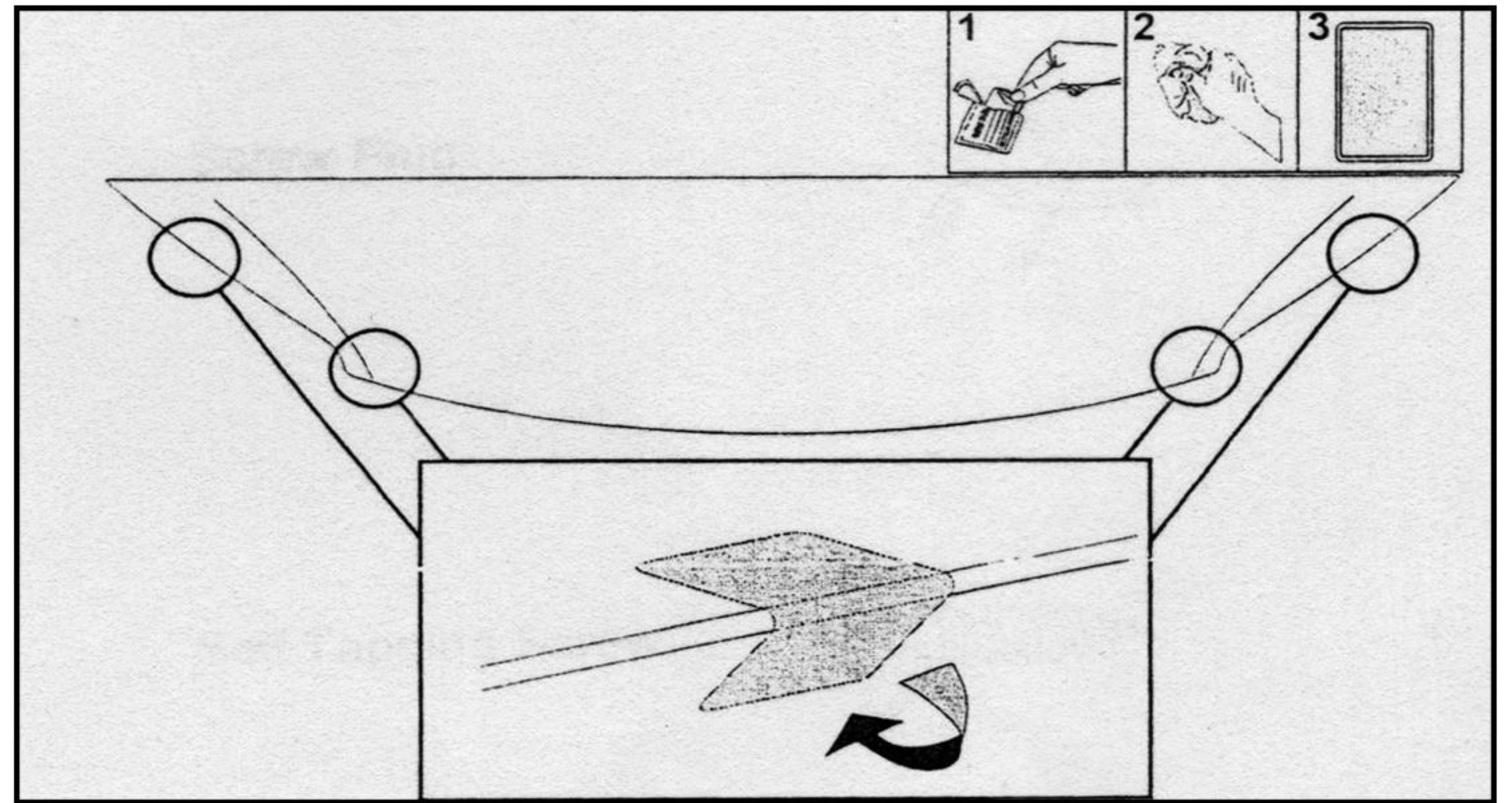

5. Clean the four metal clip locations with the alcohol wipe provided removing any pen marks. Wipe off any residue with a dry clean cloth. Adhere the abrasive resistant tape strips over the bonnet lip.

Note: Apply tape so approximately half of each strip is adhered to the top side and half is adhered to the underside of bonnet.

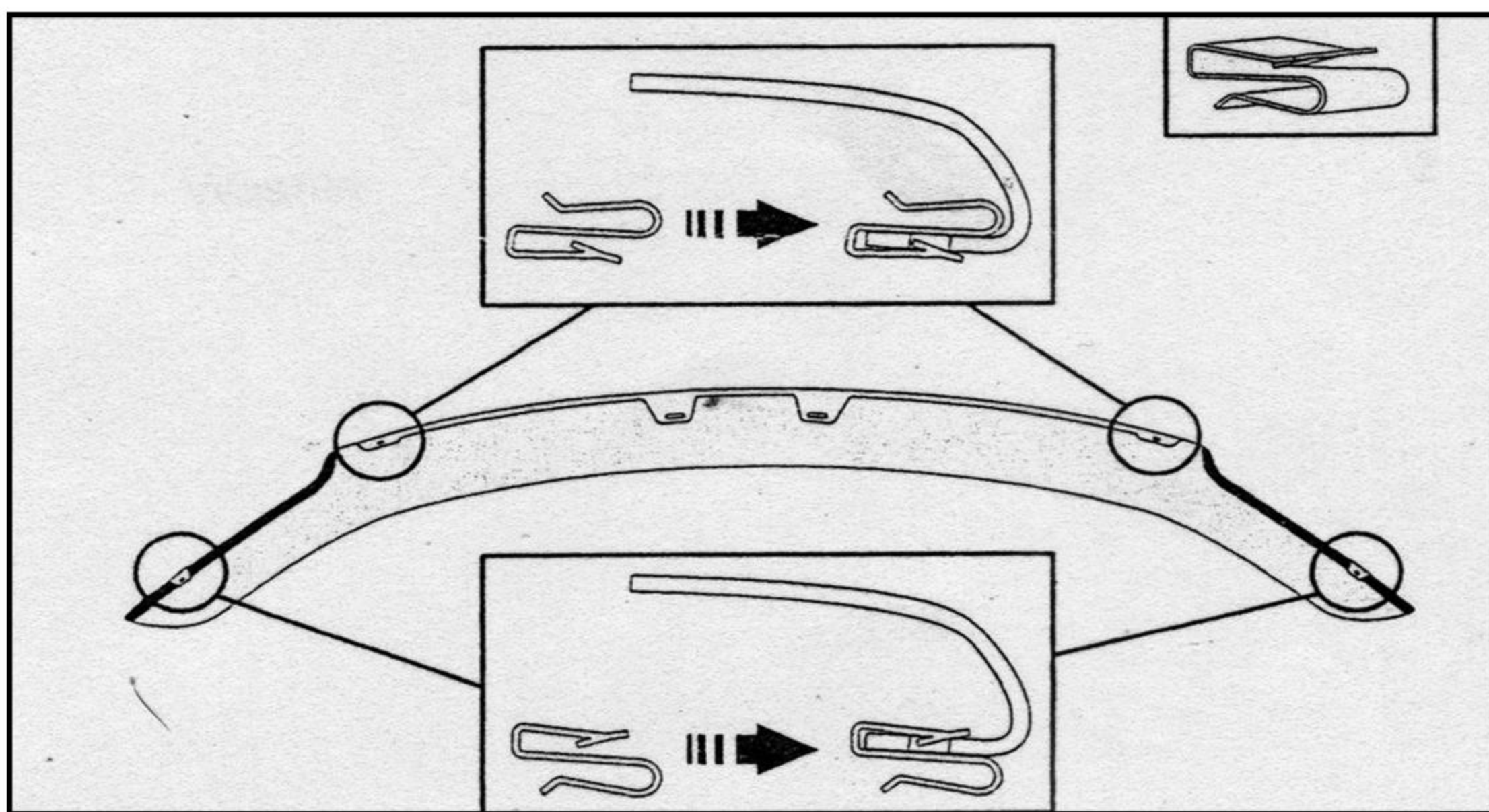

6. Attach the four metal clips to the bonnet protector. At the inner clip locations fit the clips upside down.

Note: You will hear a definite click when the clips engage with the Bonnet Protector.

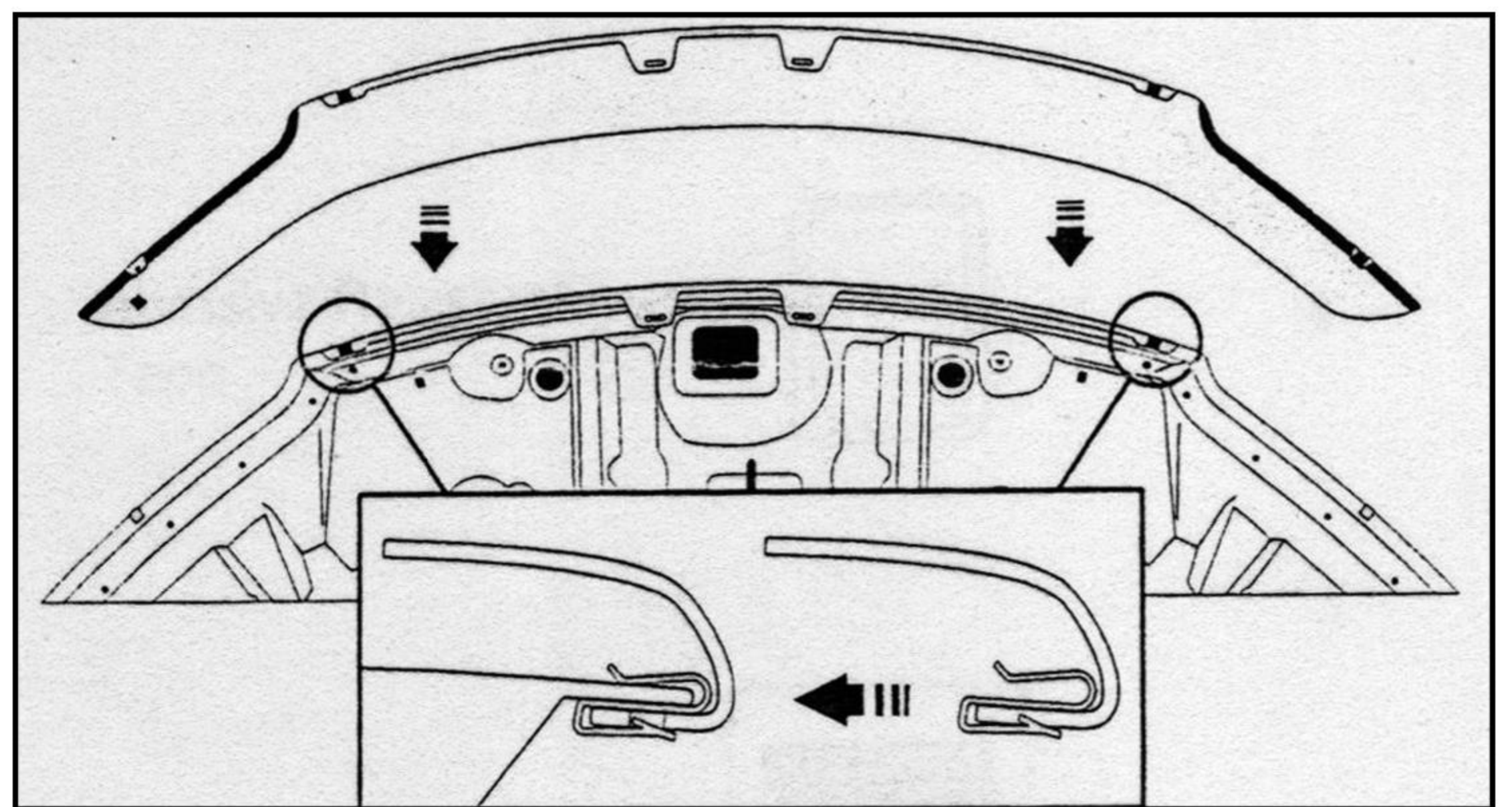

7. Align the Bonnet Protector centrally onto the bonnet. Slide inner metal clips onto the bonnet lip, ensuring the Bonnet Protector corresponds to the screw plug locations on the underside of the bonnet.

Note: Ensure the metal clips are over the abrasion resistant tape and do not come into direct contact with the bonnet.

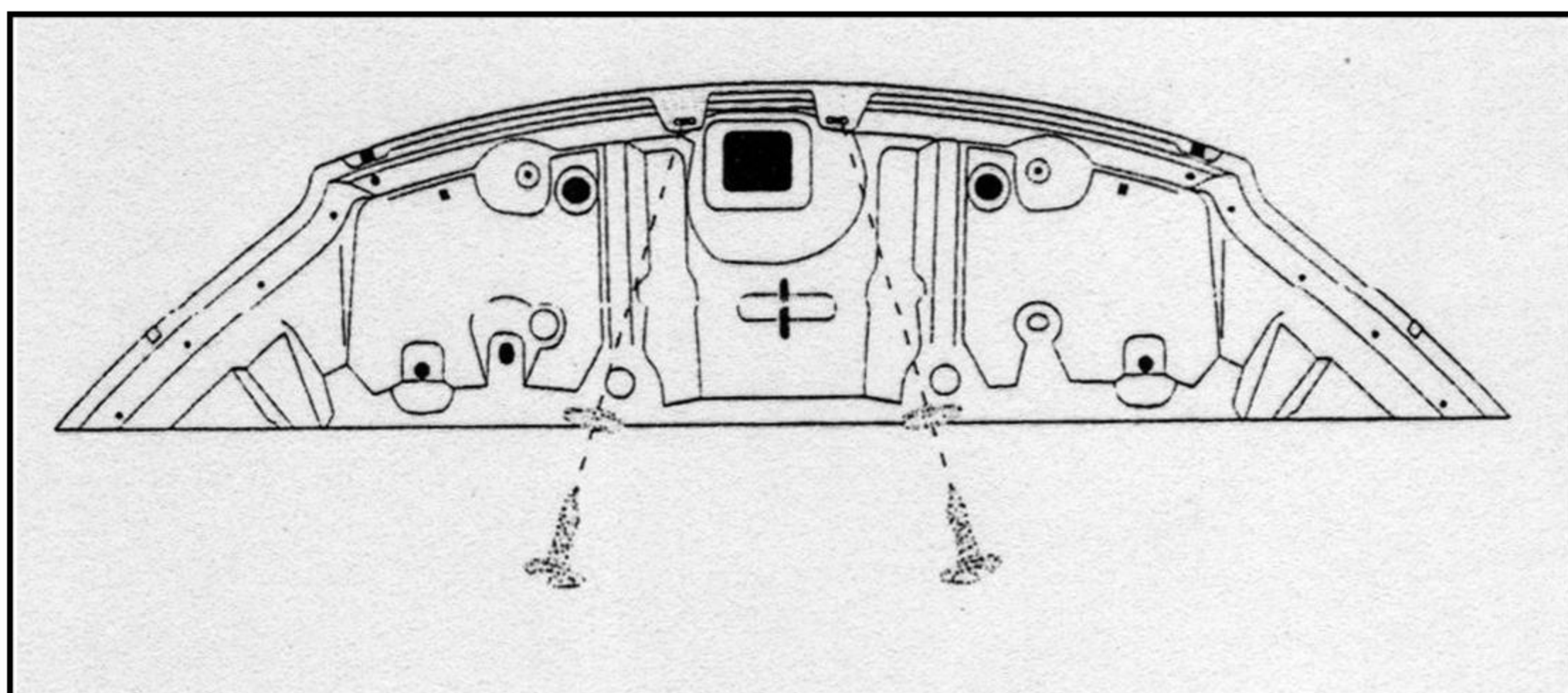

8. Secure the Bonnet Protector into place using the two screws and two washers.

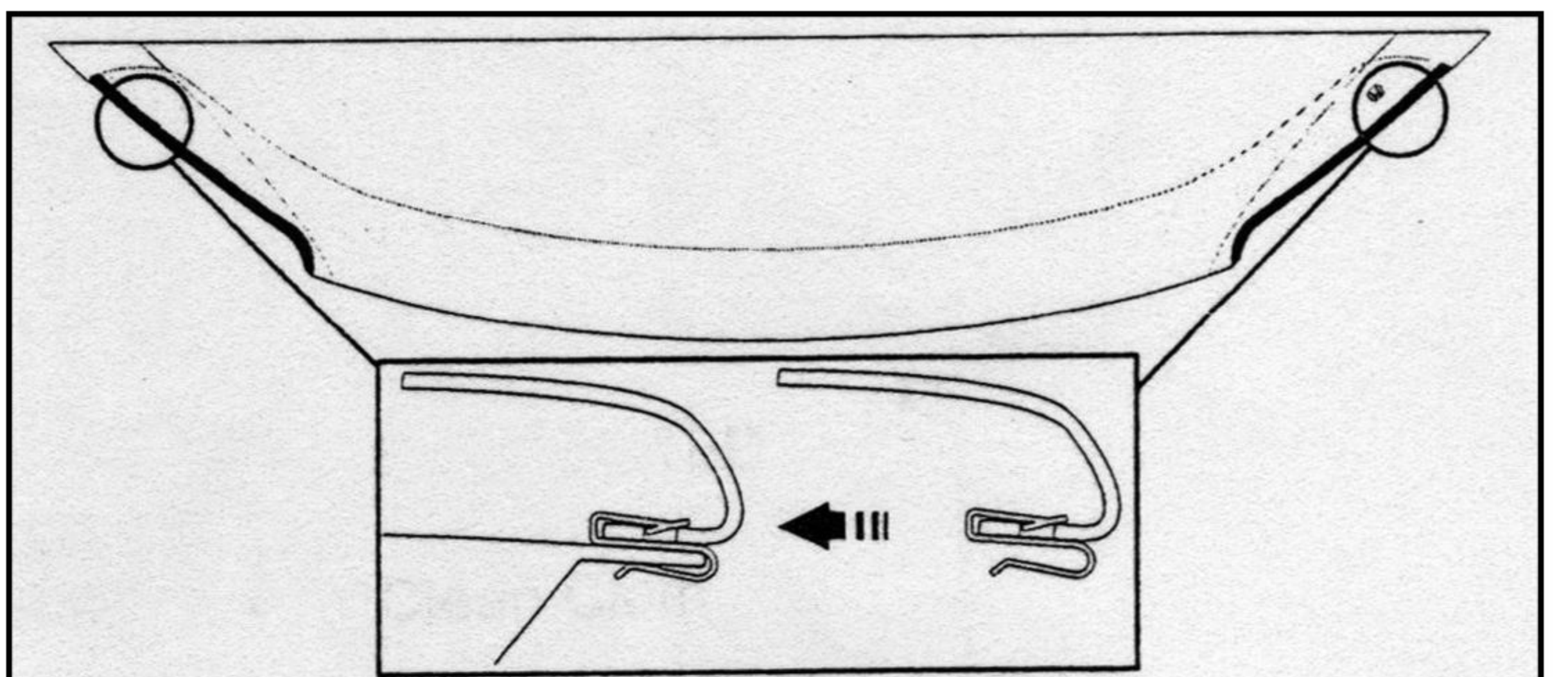

9. Push the two outer metal clips onto the bonnet lip. Note: Ensure the metal clips are over the abrasion resistant tape and do not come into direct contact with the bonnet.

10. Place Fitting Instructions in glove box for future use.

Note: To remove Bonnet Protector follow the Installation Instructions in reverse order.